

**TSSOP-8 20V Dual N Channel Enhancement with ESD 双 N 沟道增强型带静电保护  
MOS Field Effect Transistor 场效应管**

**■ Features 特点**

Low on-resistance 低导通电阻

$R_{DS(ON)}=12.5m\Omega(\text{Type})@V_{GS}=4.5V$

$R_{DS(ON)}=16m\Omega(\text{Type})@V_{GS}=2.5V$

$R_{DS(ON)}=22m\Omega(\text{Type})@V_{GS}=1.8V$

**■ Applications 应用**

Portable Equipment 桌面设备

Battery Powered System 电池电源系统

Power Management in Note Book 笔记本电源管理

**■ Internal Schematic Diagram 内部结构**

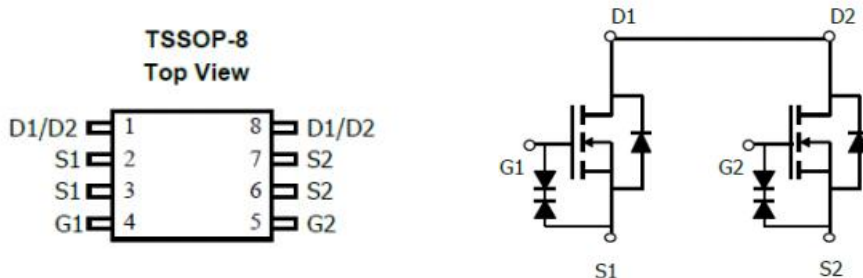

**■ Absolute Maximum Ratings 最大额定值**

Characteristic 特性参数	Symbol 符号	Rat 额定值	Unit 单位
Drain-Source Voltage 漏极-源极电压	$BV_{DSS}$	20	V
Gate- Source Voltage 栅极-源极电压	$V_{GS}$	$\pm 10$	V
Drain Current (continuous)漏极电流-连续	$I_D$ (at $T_A = 25^\circ C$ )	7	A
Drain Current (pulsed)漏极电流-脉冲	$I_{DM}$	30	A
Total Device Dissipation 总耗散功率	$P_D$ (at $T_A = 25^\circ C$ )	1500	mW
Thermal Resistance Junction-Ambient 热阻	$R_{\theta JA}$	83	$^\circ C/W$
Junction/Storage Temperature 结温/储存温度	$T_J, T_{stg}$	-55~150	$^\circ C$

■ Electrical Characteristics 电特性

( $T_A=25^{\circ}\text{C}$  unless otherwise noted 如无特殊说明, 温度为  $25^{\circ}\text{C}$ )

Characteristic 特性参数	Symbol 符号	Min 最小值	Typ 典型值	Max 最大值	Unit 单位
Drain-Source Breakdown Voltage 漏极-源极击穿电压( $I_D=250\mu\text{A}, V_{GS}=0\text{V}$ )	$BV_{DSS}$	20	—	—	V
Gate Threshold Voltage 栅极开启电压( $I_D=250\mu\text{A}, V_{GS}=V_{DS}$ )	$V_{GS(th)}$	0.4	0.75	1.0	V
Zero Gate Voltage Drain Current 零栅压漏极电流( $V_{GS}=0\text{V}, V_{DS}=20\text{V}$ )	$I_{DSS}$	—	—	1	$\mu\text{A}$
Gate Body Leakage 栅极漏电流( $V_{GS}=\pm 8\text{V}, V_{DS}=0\text{V}$ )	$I_{GSS}$	—	—	$\pm 10$	$\mu\text{A}$
Static Drain-Source On-State Resistance 静态漏源导通电阻( $I_D=7\text{A}, V_{GS}=4.5\text{V}$ ) ( $I_D=6.5\text{A}, V_{GS}=2.5\text{V}$ ) ( $I_D=5\text{A}, V_{GS}=1.8\text{V}$ )	$R_{DS(ON)}$	—	12.5 16 22	19 22 30	$\text{m}\Omega$
Diode Forward Voltage Drop 内附二极管正向压降( $I_{SD}=1\text{A}, V_{GS}=0\text{V}$ )	$V_{SD}$	—	0.7	1.3	V
Input Capacitance 输入电容 ( $V_{GS}=0\text{V}, V_{DS}=10\text{V}, f=1\text{MHz}$ )	$C_{ISS}$	—	1300	—	pF
Common Source Output Capacitance 共源输出电容( $V_{GS}=0\text{V}, V_{DS}=10\text{V}, f=1\text{MHz}$ )	$C_{OSS}$	—	195	—	pF
Reverse Transfer Capacitance 反馈电容 ( $V_{GS}=0\text{V}, V_{DS}=10\text{V}, f=1\text{MHz}$ )	$C_{RSS}$	—	155	—	pF
Total Gate Charge 栅极电荷密度 ( $V_{DS}=10\text{V}, I_D=7\text{A}, V_{GS}=4.5\text{V}$ )	$Q_g$	—	16	—	nC
Gate Source Charge 栅源电荷密度 ( $V_{DS}=10\text{V}, I_D=7\text{A}, V_{GS}=4.5\text{V}$ )	$Q_{gs}$	—	2	—	nC
Gate Drain Charge 栅漏电荷密度 ( $V_{DS}=10\text{V}, I_D=7\text{A}, V_{GS}=4.5\text{V}$ )	$Q_{gd}$	—	7	—	nC
Turn-ON Delay Time 开启延迟时间 ( $V_{DS}=10\text{V}, I_D=7\text{A}, R_{GEN}=3.3\Omega, V_{GS}=4.5\text{V}$ )	$t_{d(on)}$	—	7	—	ns
Turn-ON Rise Time 开启上升时间 ( $V_{DS}=10\text{V}, I_D=7\text{A}, R_{GEN}=3.3\Omega, V_{GS}=4.5\text{V}$ )	$t_r$	—	11	—	ns
Turn-OFF Delay Time 关断延迟时间 ( $V_{DS}=10\text{V}, I_D=7\text{A}, R_{GEN}=3.3\Omega, V_{GS}=4.5\text{V}$ )	$t_{d(off)}$	—	64	—	ns
Turn-OFF Fall Time 关断下降时间 ( $V_{DS}=10\text{V}, I_D=7\text{A}, R_{GEN}=3.3\Omega, V_{GS}=4.5\text{V}$ )	$t_f$	—	32	—	ns

■ Typical Characteristic Curve 典型特性曲线

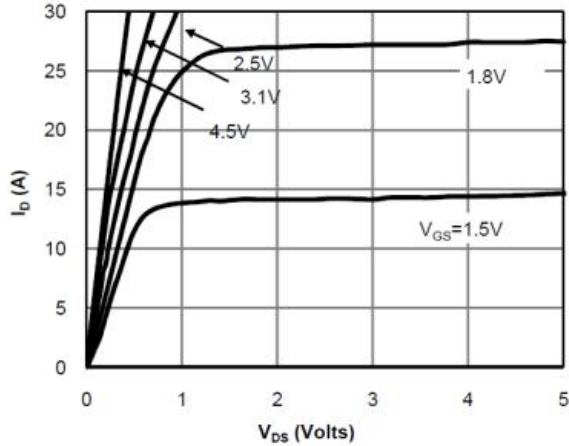

Figure 1: Output Characteristics

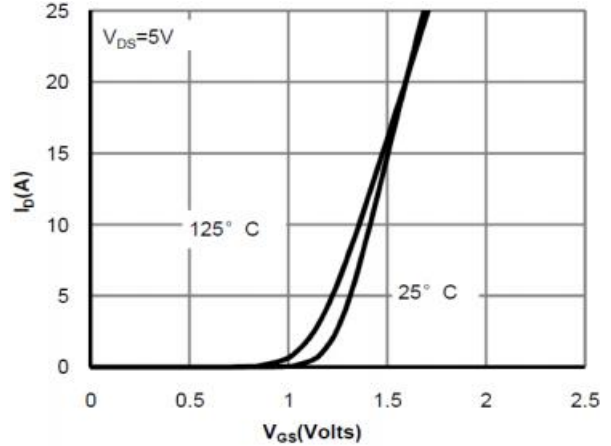

Figure 2: Transfer Characteristics

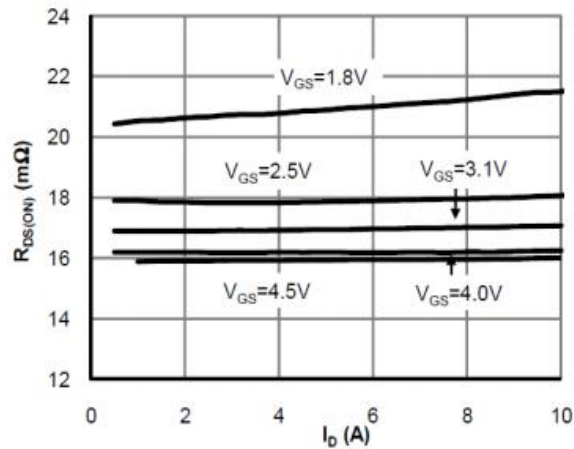

Figure 3: On-Resistance vs. Drain Current

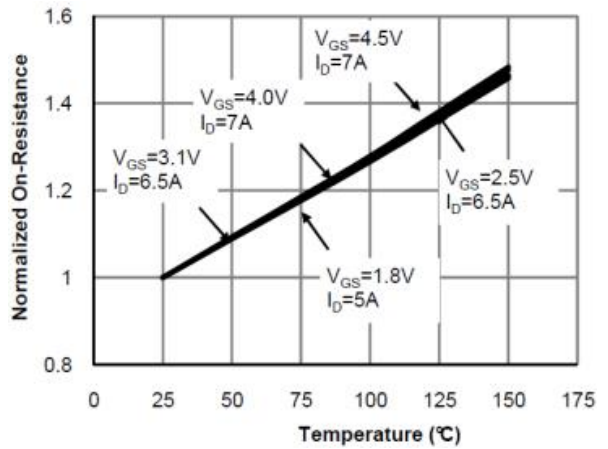

Figure 4: On-Resistance vs. Temperature

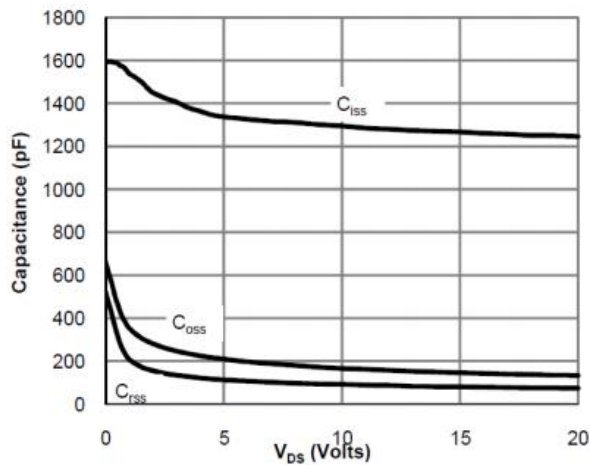

Figure 5: Capacitance Characteristics

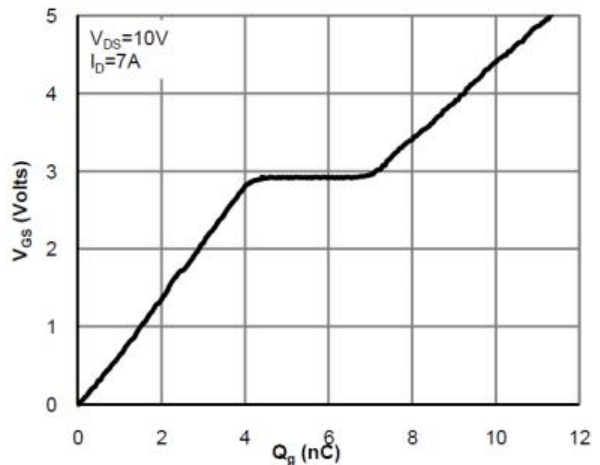

Figure 6: Gate-Charge Characteristics

■ Typical Characteristic Curve 典型特性曲线

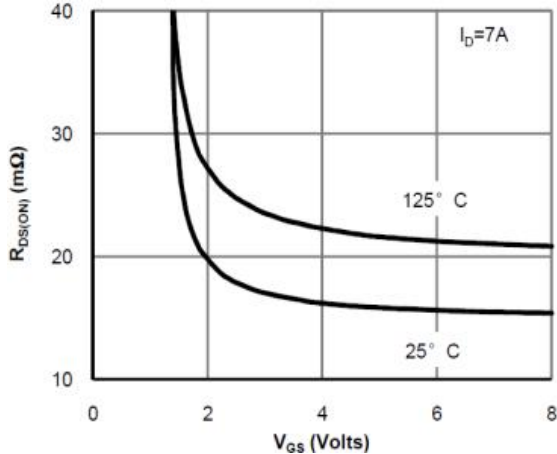

Figure 7: Drain Current vs.  $V_{GS}$

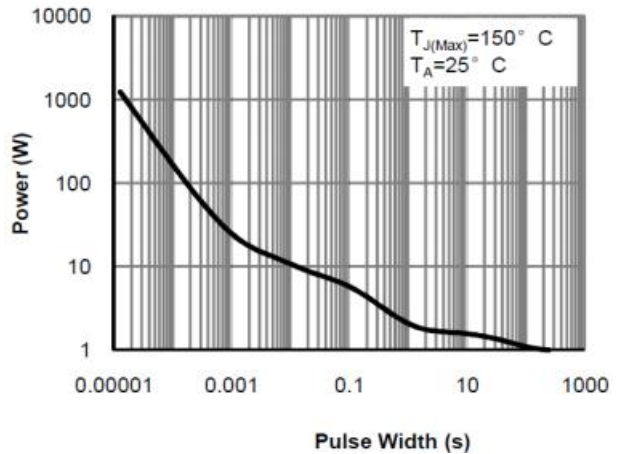

Figure 8: Power Rating Curve

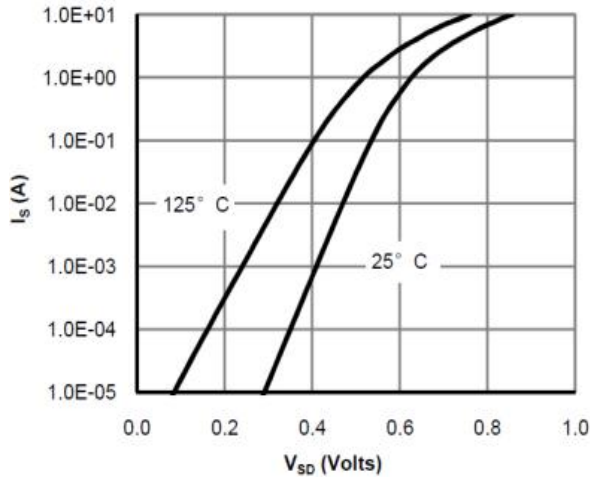

Figure 9: Diode Characteristics

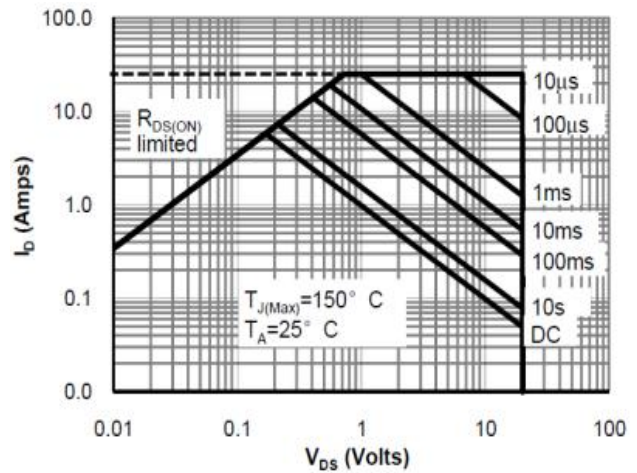

Figure 10: Safe Operating Area

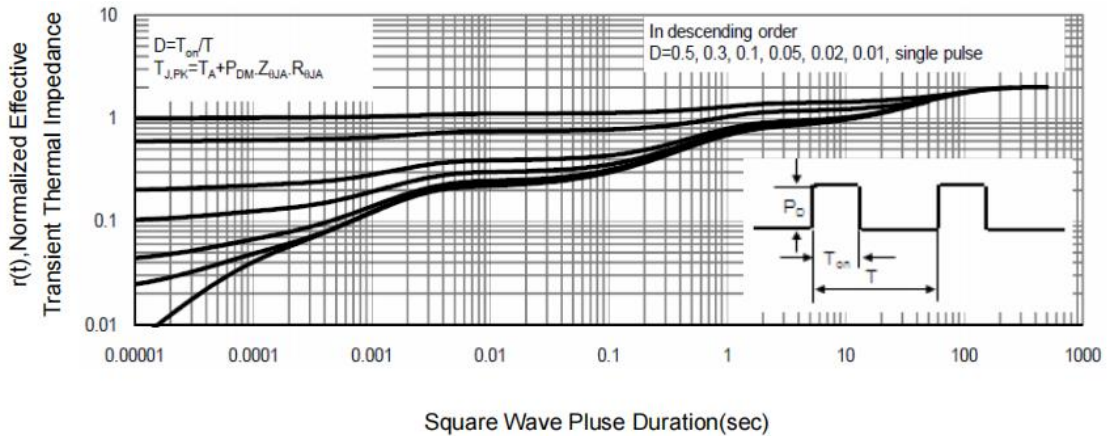
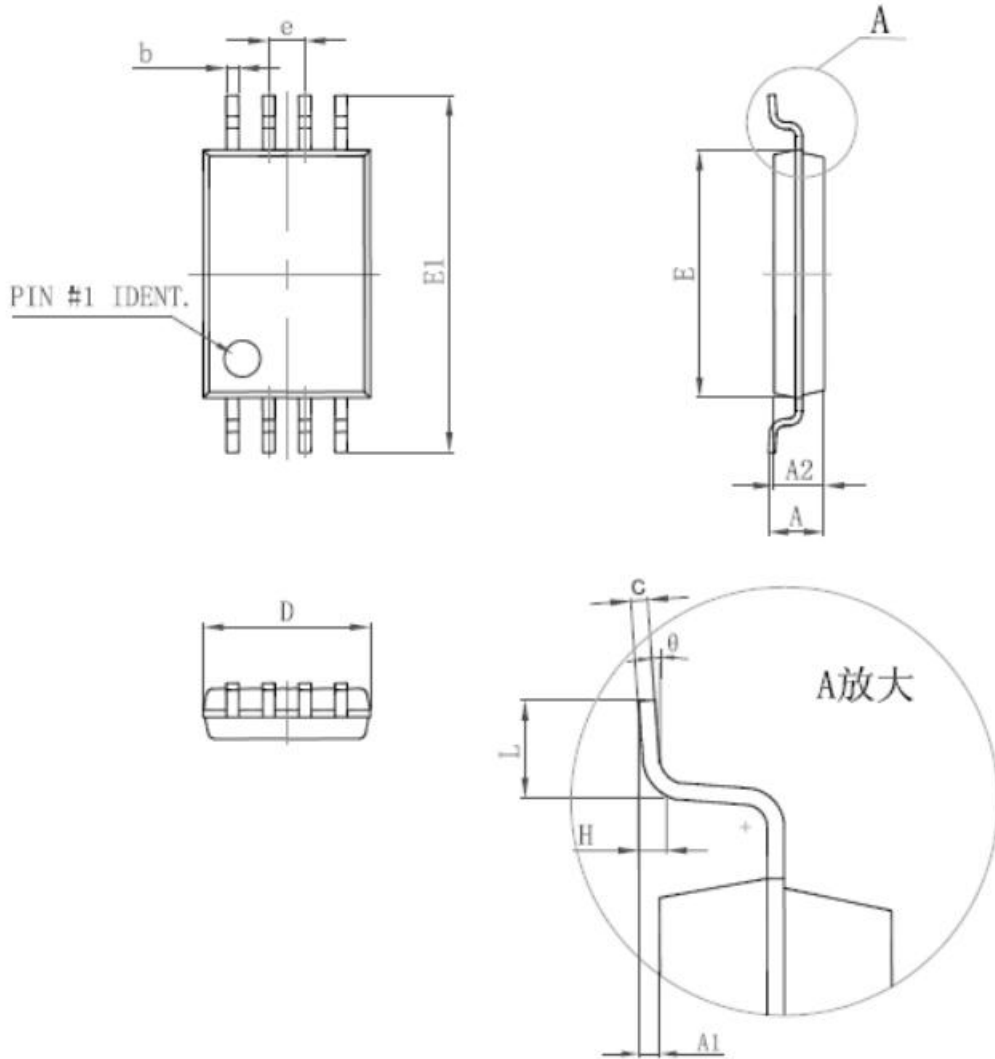

Figure 11: Transient Thermal Response Curve

■ Dimension 外形封装尺寸



Symbol	Dimensions In Millimeters		Dimensions In Inches	
	Min	Max	Min	Max
D	2.900	3.100	0.114	0.122
E	4.300	4.500	0.169	0.177
b	0.190	0.300	0.007	0.012
c	0.090	0.200	0.004	0.008
E1	6.250	6.550	0.246	0.258
A		1.100		0.043
A2	0.800	1.000	0.031	0.039
A1	0.020	0.150	0.001	0.006
e	0.65 (BSC)		0.026 (BSC)	
L	0.500	0.700	0.020	0.028
H	0.25 (TYP)		0.01 (TYP)	
theta	1°	7°	1°	7°