

**TO-252 N Channel Enhancement 沟道增强型
MOS Field Effect Transistor 场效应管**

■ **Features 特点**

Low on-resistance 低导通电阻
 $R_{DS(ON)}=2.5m\Omega(\text{Type})@V_{GS}=10V$
 $R_{DS(ON)}=3.1m\Omega(\text{Type})@V_{GS}=4.5V$

■ **Applications 应用**

Load switch 负载开关
 PWM Application 脉宽调制
 Power Management 电源管理

■ **Internal Schematic Diagram 内部结构**

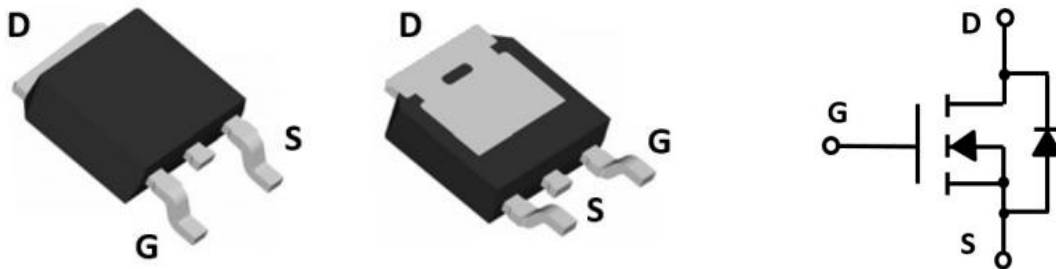

■ **Absolute Maximum Ratings 最大额定值**

Characteristic 特性参数	Symbol 符号	Rat 额定值	Unit 单位
Drain-Source Voltage 漏极-源极电压	BV_{DSS}	40	V
Gate- Source Voltage 栅极-源极电压	V_{GS}	± 20	V
Drain Current (continuous)漏极电流-连续	I_D (at $T_C = 25^\circ C$ at $T_C = 100^\circ C$)	150 120	A
Drain Current (pulsed)漏极电流-脉冲	I_{DM}	780	A
Total Device Dissipation 总耗散功率	$P_D(\text{at } T_C = 25^\circ C)$	157	W
Thermal Resistance Junction-Case 热阻	$R_{\theta JC}$	0.8	$^\circ C/W$
Avalanche Energy Single Pulse 雪崩能量	E_{AS}	330	mJ
Junction/Storage Temperature 结温/储存温度	T_J, T_{stg}	-55~150	$^\circ C$

■ Electrical Characteristics 电特性

($T_A=25^{\circ}\text{C}$ unless otherwise noted 如无特殊说明, 温度为 25°C)

Characteristic 特性参数	Symbol 符号	Min 最小值	Typ 典型值	Max 最大值	Unit 单位
Drain-Source Breakdown Voltage 漏极-源极击穿电压($I_D=250\mu\text{A}, V_{GS}=0\text{V}$)	BV_{DSS}	40	—	—	V
Gate Threshold Voltage 栅极开启电压($I_D=250\mu\text{A}, V_{GS}=V_{DS}$)	$V_{GS(th)}$	1	1.9	2.5	V
Zero Gate Voltage Drain Current 零栅压漏极电流($V_{GS}=0\text{V}, V_{DS}=40\text{V}$)	I_{DSS}	—	—	1	μA
Gate Body Leakage 栅极漏电流($V_{GS}=\pm 20\text{V}, V_{DS}=0\text{V}$)	I_{GSS}	—	—	± 100	nA
Static Drain-Source On-State Resistance 静态漏源导通电阻($I_D=20\text{A}, V_{GS}=10\text{V}$) ($I_D=20\text{A}, V_{GS}=4.5\text{V}$)	$R_{DS(ON)}$	—	2.5 3.1	3.5 4.5	$\text{m}\Omega$
Diode Forward Voltage Drop 内附二极管正向压降($I_{SD}=1\text{A}, V_{GS}=0\text{V}$)	V_{SD}	—	—	1	V
Input Capacitance 输入电容 ($V_{GS}=0\text{V}, V_{DS}=20\text{V}, f=1\text{MHz}$)	C_{ISS}	—	5595	—	pF
Common Source Output Capacitance 共源输出电容($V_{GS}=0\text{V}, V_{DS}=20\text{V}, f=1\text{MHz}$)	C_{OSS}	—	411	—	pF
Reverse Transfer Capacitance 反馈电容 ($V_{GS}=0\text{V}, V_{DS}=20\text{V}, f=1\text{MHz}$)	C_{RSS}	—	340	—	pF
Total Gate Charge 栅极电荷密度 ($V_{DS}=20\text{V}, I_D=20\text{A}, V_{GS}=10\text{V}$)	Q_g	—	68	—	nC
Gate Source Charge 栅源电荷密度 ($V_{DS}=20\text{V}, I_D=20\text{A}, V_{GS}=10\text{V}$)	Q_{gs}	—	18	—	nC
Gate Drain Charge 栅漏电荷密度 ($V_{DS}=20\text{V}, I_D=20\text{A}, V_{GS}=10\text{V}$)	Q_{gd}	—	5	—	nC
Turn-ON Delay Time 开启延迟时间 ($V_{DS}=20\text{V}, I_D=20\text{A}, R_{GEN}=3\Omega, V_{GS}=10\text{V}$)	$t_{d(on)}$	—	13	—	ns
Turn-ON Rise Time 开启上升时间 ($V_{DS}=20\text{V}, I_D=20\text{A}, R_{GEN}=3\Omega, V_{GS}=10\text{V}$)	t_r	—	10	—	ns
Turn-OFF Delay Time 关断延迟时间 ($V_{DS}=20\text{V}, I_D=20\text{A}, R_{GEN}=3\Omega, V_{GS}=10\text{V}$)	$t_{d(off)}$	—	58	—	ns
Turn-OFF Fall Time 关断下降时间 ($V_{DS}=20\text{V}, I_D=20\text{A}, R_{GEN}=3\Omega, V_{GS}=10\text{V}$)	t_f	—	11	—	ns

■ Typical Characteristic Curve 典型特性曲线

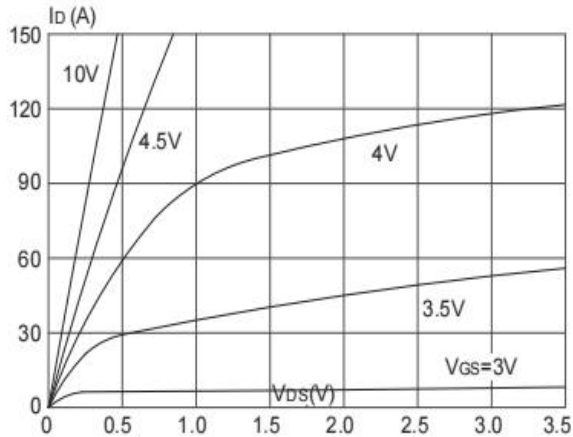

Figure 1: Output Characteristics

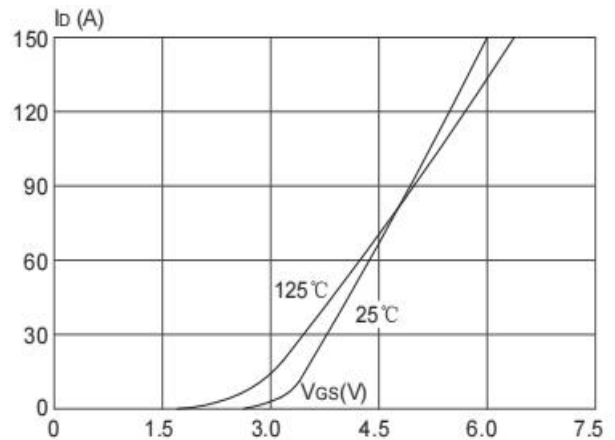

Figure 2: Transfer Characteristics

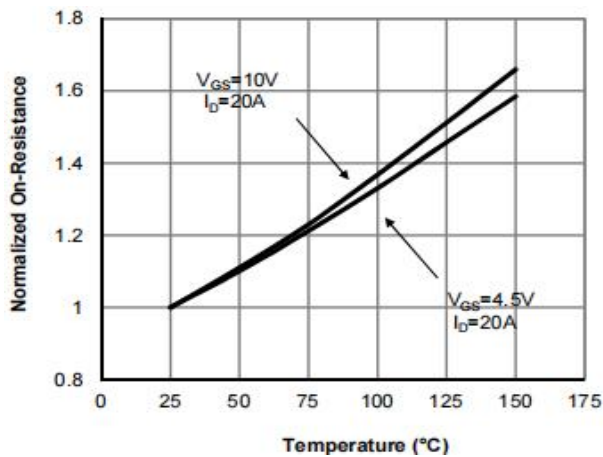

Figure 3: On-Resistance vs. T_j

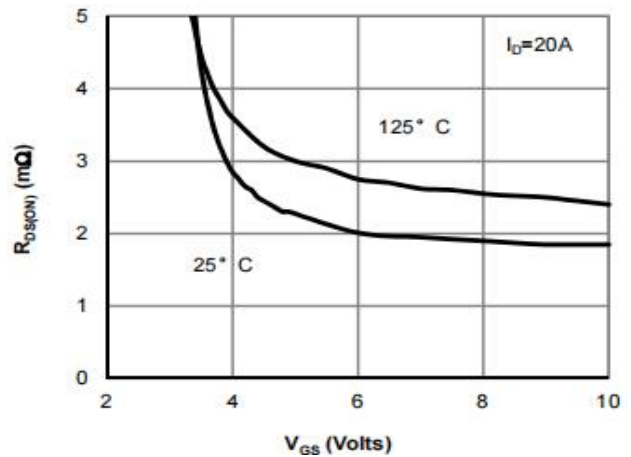

Figure 4: On-Resistance vs. V_{GS}

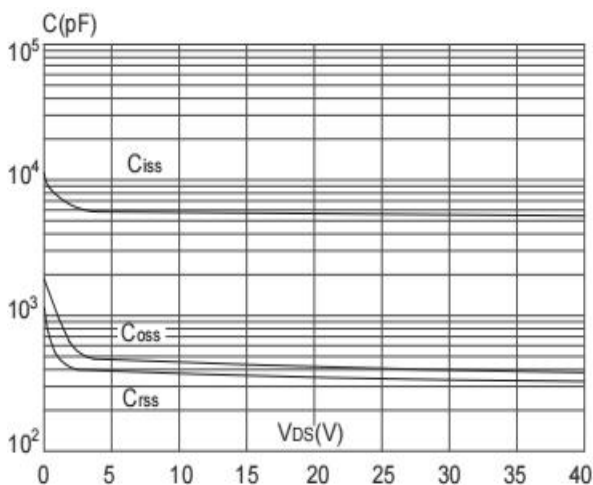

Figure 5: Capacitance Characteristics

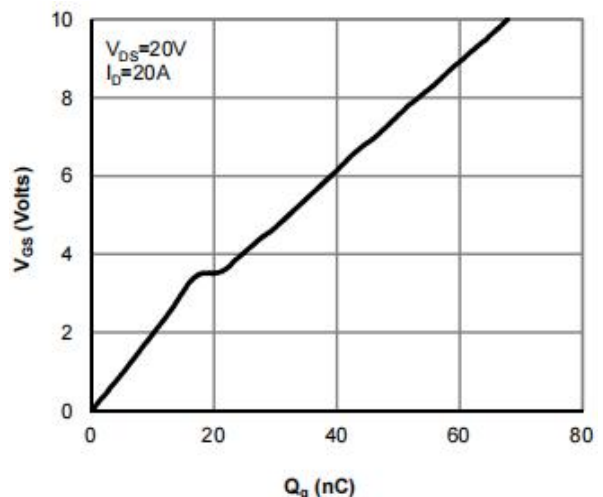

Figure 6: Gate-Charge Characteristics

■ Typical Characteristic Curve 典型特性曲线

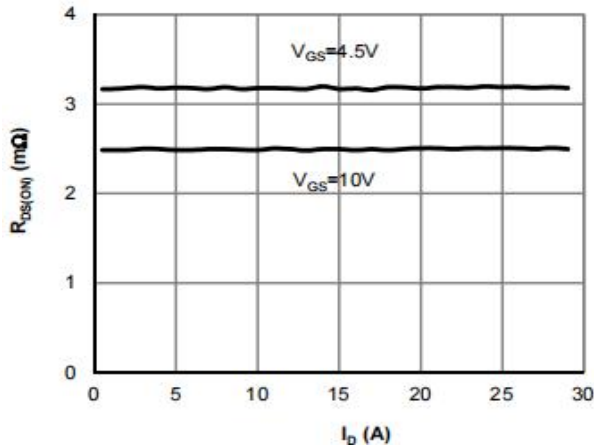

Figure 7: On-Resistance vs. Drain Current

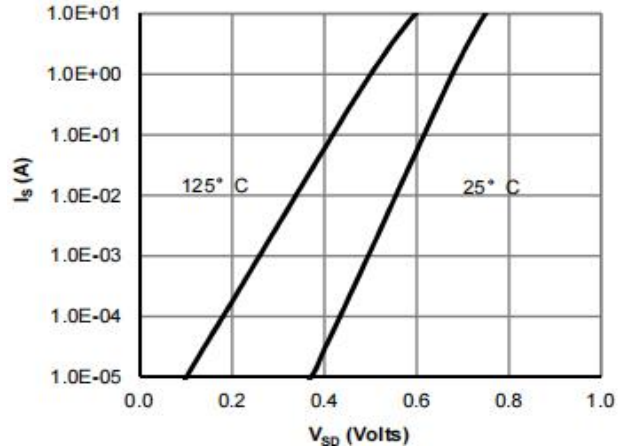

Figure 8: Diode Characteristics

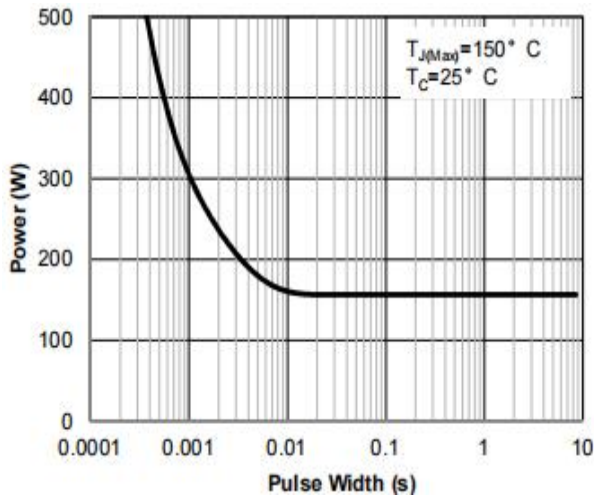

Figure 9: Power Rating Characteristics

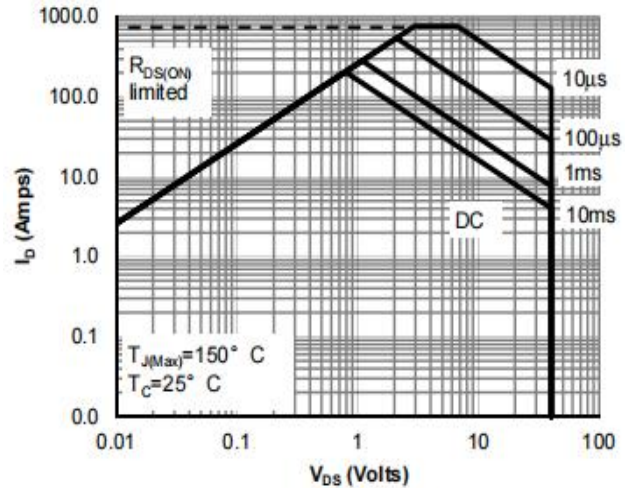

Figure 10: Safe Operating Area

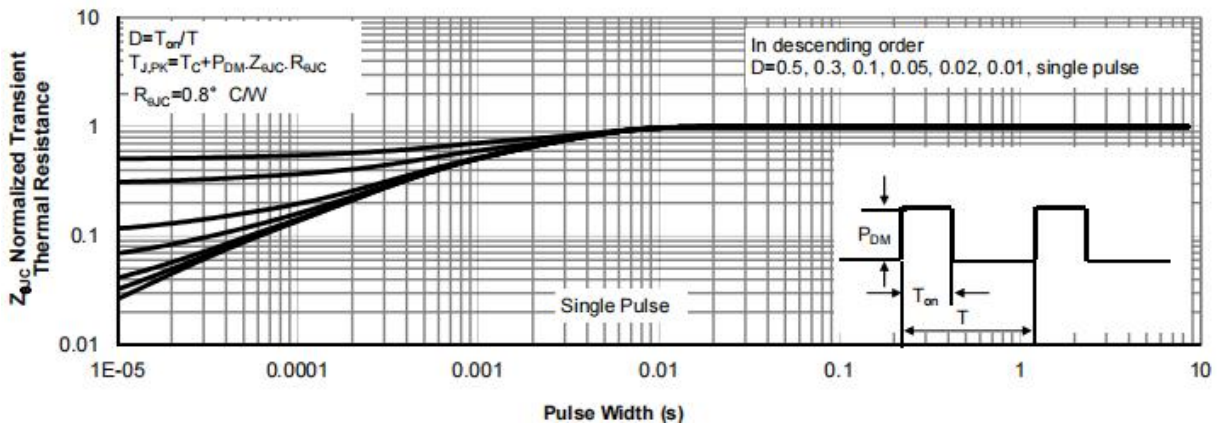
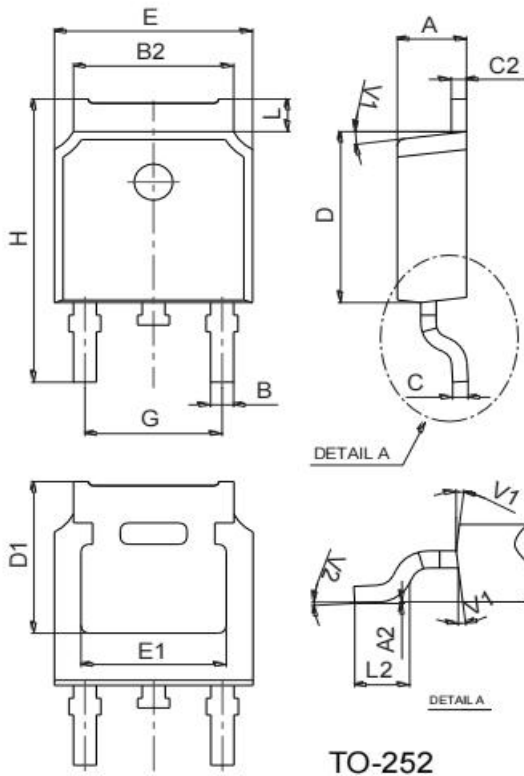

Figure 11: Transient Thermal Response Curve

■ Package Dimension 外形封装尺寸



Ref.	Dimensions					
	Millimeters			Inches		
	Min.	Typ.	Max.	Min.	Typ.	Max.
A	2.10		2.50	0.083		0.098
A2	0		0.10	0		0.004
B	0.66		0.86	0.026		0.034
B2	5.18		5.48	0.202		0.216
C	0.40		0.60	0.016		0.024
C2	0.44		0.58	0.017		0.023
D	5.90		6.30	0.232		0.248
D1	5.30REF			0.209REF		
E	6.40		6.80	0.252		0.268
E1	4.63			0.182		
G	4.47		4.67	0.176		0.184
H	9.50		10.70	0.374		0.421
L	1.09		1.21	0.043		0.048
L2	1.35		1.65	0.053		0.065
V1		7°			7°	
V2	0°		6°	0°		6°

■ Reel Dimension 编带卷盘尺寸

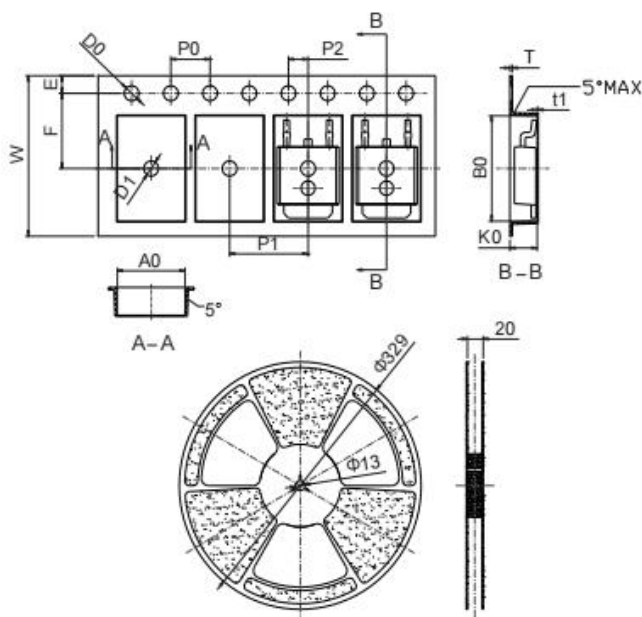

Ref.	Dimensions					
	Millimeters			Inches		
	Min.	Typ.	Max.	Min.	Typ.	Max.
W	15.90	16.00	16.10	0.626	0.630	0.634
E	1.65	1.75	1.85	0.065	0.069	0.073
F	7.40	7.50	7.60	0.291	0.295	0.299
D0	1.40	1.50	1.60	0.055	0.059	0.063
D1	1.40	1.50	1.60	0.055	0.059	0.063
P0	3.90	4.00	4.10	0.154	0.157	0.161
P1	7.90	8.00	8.10	0.311	0.315	0.319
P2	1.90	2.00	2.10	0.075	0.079	0.083
A0	6.85	6.90	7.00	0.270	0.271	0.276
B0	10.45	10.50	10.60	0.411	0.413	0.417
K0	2.68	2.78	2.88	0.105	0.109	0.113
T	0.24		0.27	0.009		0.011
t1	0.10			0.004		
10P0	39.80	40.00	40.20	1.567	1.575	1.583