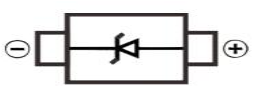
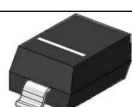

SOD-323 Schottky Barrier Diode 肖特基势垒二极管

Internal Configuration & Device Marking 内部结构与产品打标

Type 型号	RB551V-30	
Pin 管脚		
Mark 打标	D	

Absolute Maximum Ratings 最大额定值

Characteristic 特性参数	Symbol 符号	Rat 额定值	Unit 单位
Peak Reverse Voltage 反向峰值电压	V_{RM}	30	V
DC Reverse Voltage 直流反向电压	V_R	20	
Forward Work Current 正向工作电流	I_o	500	mA
Peak Forward Surge Current 正向峰值浪涌电流	I_{FSM}	2000	mA
Power dissipation 耗散功率	$P_D(T_A=25^\circ C)$	200	mW
Thermal Resistance J-A 结到环境热阻	$R_{\theta JA}$	500	$^\circ C/W$
Junction and Storage Temperature 结温和储藏温度	T_J, T_{stg}	-55to+125 $^\circ C$	

Electrical Characteristics 电特性

($T_A=25^\circ C$ unless otherwise noted 如无特殊说明, 温度为 $25^\circ C$)

Characteristic 特性参数	Symbol 符号	Min 最小值	Max 最大值	Unit 单位
Reverse Breakdown Voltage 反向击穿电压($I_R=0.1mA$)	$V_{(BR)}$	30	—	V
Reverse Leakage Current 反向漏电流($V_R=20V$)	I_R	—	100	μA
Forward Voltage($I_F=100mA$) 正向电压($I_F=500mA$)	V_F		0.36 0.47	V
Diode Capacitance 二极管电容($V_R=1V, f=1MHz$)	C_D	—	100	pF

■ Typical Characteristic Curve 典型特性曲线

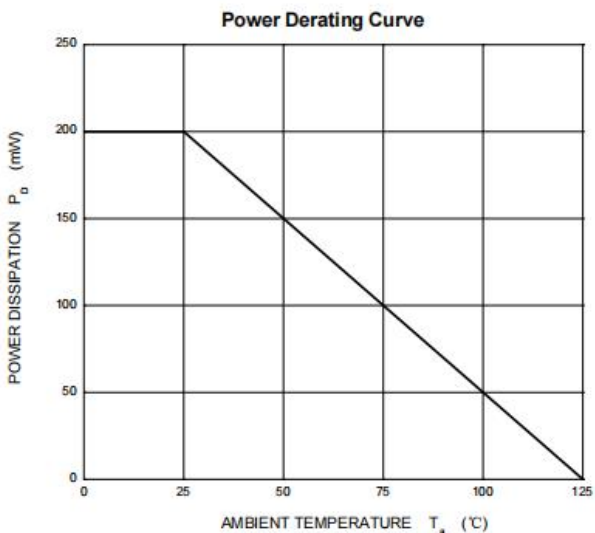
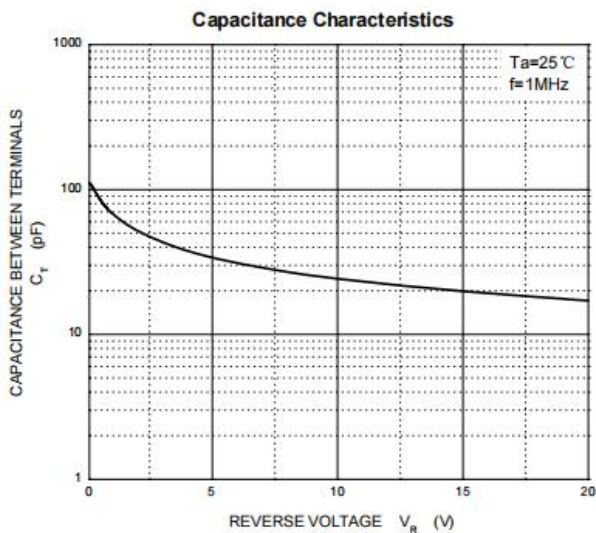
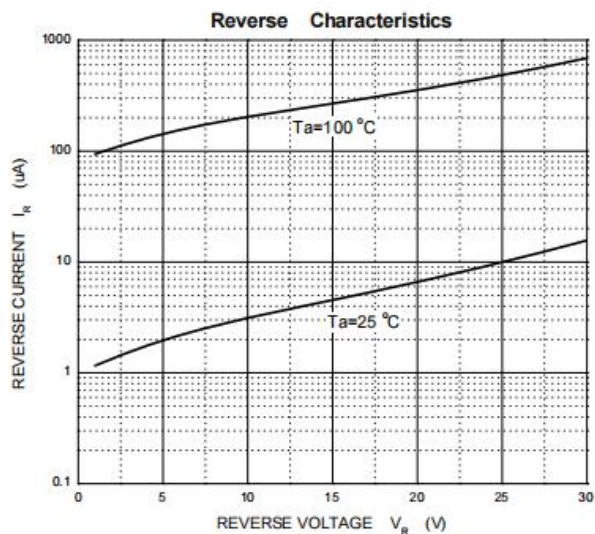
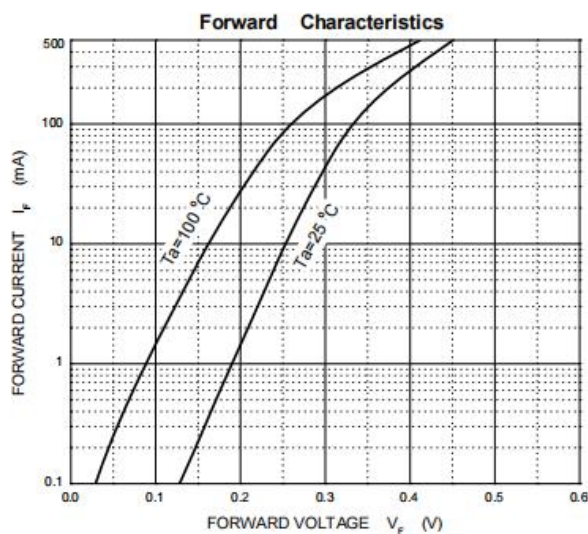

■Dimension 外形封装尺寸

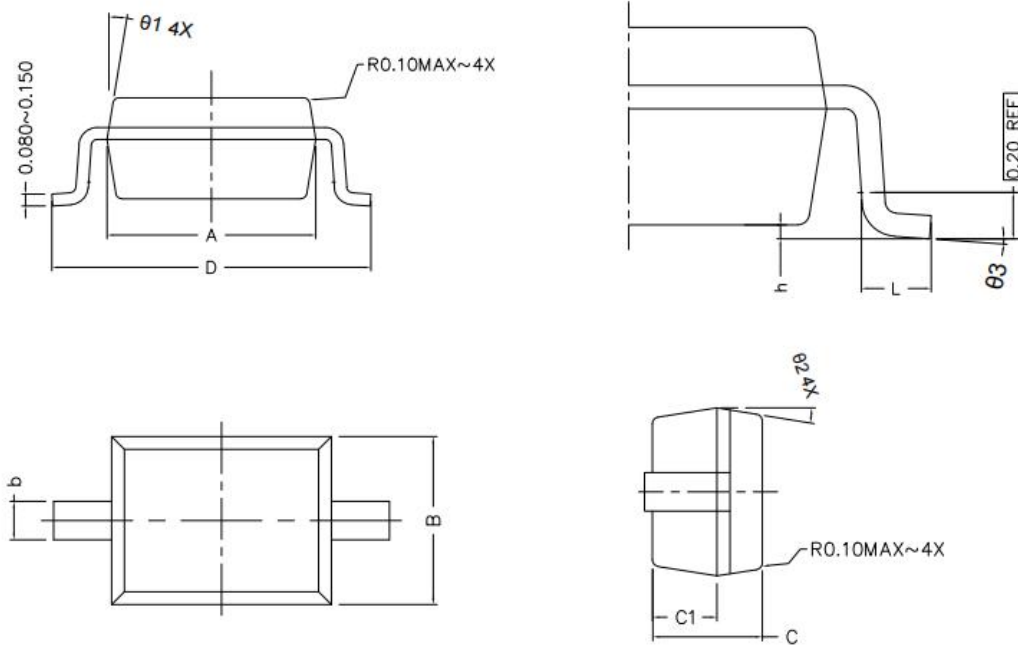

COMMON DIMENSIONS (UNITS OF MEASURE IS mm)			
	MIN	NORMAL	MAX
A	1.600	1.700	1.800
B	1.200	1.300	1.400
C	0.750	0.850	0.950
C1	0.450	0.500	0.550
D	2.450	2.600	2.750
L	0.200	0.300	0.400
b	0.200	0.300	0.400
h	0.010	0.050	0.100
$\theta 1$	9° TYPE		
$\theta 2$	9° TYPE		
$\theta 3$	0° ~ 8°		